



ETSI Front View of G7860A

Description

G7860A supports both MPLS-TP and Carrier Ethernet (EPL, EVPL, EPLAN, EVC defined in MEF) for packet transportation. In addition to native Ethernet transport, G7860A can be used as the gateway for PDH and SDH/SONET networks to enter PSNs using Circuit Emulation and Encapsulation technologies. Encapsulation technologies include TDMoE, TDMoIP, and TDMoMPLS. Circuit Emulation include CESoPSN (NxDS0/64K) with CAS, SAToP (Unframed E1/T1), T3, and CEP (SDH/SONET paths). Pseudowires make grooming and multiplexing DS0, E1/T1, T3 and SDH/SONET paths easier, and service integrity can also be monitored and protected via packet network protection schemes.

One G7860A with up to 81G packet switching capacity supports six GbE/10GbE SFP+ and four 1GbE SFP built-in interfaces along with 16 E1/T1 built-in ports. With two hot-swappable plug-in slots, the system capacity can be scaled up with additional E1/T1 and T3 ports, STM-n/OC-n, or GbE electrical/optical interfaces.

G7860A provides high availability and reliability required by Carrier, Power Utility, Military, Government and Transportation applications by supporting MPLS-TP LSP 1:1/1+1 protection and ERPS, with protection switching time <50ms. Ethernet and MPLS section and end-to-end OAM are also provided for monitoring service integrity and performance. The compact G7860A is only 1U height, but its powerful functions enable customers to provision a service-grooming hub, ring, or mesh 10G packet network with ultimate ease.

Features

Mechanical and Electrical

- 1U height, 19" width ETSI unit (front access)
- Power supply: hot swappable DC/AC, dual for redundancy
- Operating Temperature: -20 °C to 65 °C

System Capacity

- Up to 6 x GbE/10GbE SFP+ ports
- Up to 16 x 1GbE Base-T
- Up to 20 x 1GbE SFP
- Up to 80 x E1/T1 ports
- Up to 8 x STM-1/OC-3 ports or 2 x STM-4/OC-12 ports
- Up to 4 x STM-1/OC-3 MSP pairs or 2 x STM-4/OC-12 pairs
- 16 x E1/T1 ports with SCSI interface

TDM Pseudowire Services

- Circuit Emulation
 - DS0 (64K timeslots): CESoPSN (NxDS0/64K) with CAS & multiframe PW
 - Unframed E1/T1: SAToP PW
 - VC-3/4/11/12, VT-1.5/2, STS-1/3: CEP PW
- PDH Timing recovery: ACR/DCR/System
- ACR/DCR support
 - 32TE1 card: up to 32 instances
 - MB E1/T1: up to 16 instances
 - B16 card: up to 256 instances
- SDH Circuit Emulation over Packet (CEP)
- Encapsulation
 - PW/LSP (TDM over MPLS-TP),
 - "Dry martini", MEF 8 (TDM over Ethernet),
 - TDM over IP
- PDH cross-connection to SDH/SONET
- DS0 cross-connection
 - Two-way FE1(N*DS0) to FE1/VC12/STM1

MPLS-TP

- Any Ethernet port can be configured as NNI (MPLS port) or UNI (Ethernet service port)
- Bi-directional LSP
- Static LSP/PW provisioning via NMS
- Ethernet (VPWS, VPLS, H-VPLS) and TDM (CESoPSN, CEP, and SAToP) services
- MPLS-TP OAM and QoS
- TDM PW Support:
 - 32 TE1 card: up to 256 pseudowires
 - MB E1/T1: up to 256 pseudowires
 - B16 card: up to 512 pseudowires
 - DS3 card: up to 168 pseudowires

Carrier Ethernet

- L2 Switching/Bridging
- STP, RSTP, MSTP
- LLDP
- Port based VLAN and port isolation
- VLAN Stacking (Q-in-Q)
- CE OAM
 - CFM: Ethernet Service OAM (802.1ag/Y1731)
 - EFM: Ethernet Link OAM (802.3ah)
- Flow Control
- Link Aggregation Control Protocol (LACP)
- Jumbo Frame (MTU) = 9600
- EPL, EVPL, EP-LAN, EPV-LAN, EP-Tree
- E-Access: EPL-Access, EPVL-Access

Network Protection

- MPLS-TP
 - LSP 1+1/1:1
 - LSP E2E protection switching < 50ms
 - PW Redundancy
 - Based on TP OAM for fault detection
- CE
 - ERPS Ring (G.8032) Protection
 - ELPS (G.8031) Linear Protection
- SDH/SONET
 - STM-n/OC-n MSP 1+1 Protection

Management

- Fully manageable via SNMP (v1, v2, v3)
- Fully manageable via CLI
 - Serial port
 - SSH, Telnet via Ethernet
- GbE Interface in-bands
- Account Security
 - Two types of privileges: Operator (read only) and Administrator (read and write)
 - Radius Client and 802.1x Authentication
- Upload/Download NE configuration
 - TFTP
 - SFTP
- Syslog, NTP

- cross-connection
 - Two-way FE1(N*DS0) to FE1(N*DS0) cross-connection

Ethernet Pseudowire Services

- E-Line, E-LAN, E-Tree services as defined by MEF 9 and 14 and using VPWS/VPLS
- Native Ethernet packets supported
- Encapsulation: PW/LSP (MPLS-TP), VLAN tagging (1Q), VLAN double tagging (Q-in-Q)

VPLS

- VPLS & H-VPS bridging
- 32K MAC addresses
- 256 VPLS instances per device
- Split horizon to prevent forwarding loops

CoS/QoS

- 8 Priority Queues
- Scheduling: Strict Priority, WRR with Hierarchy
- Ingress Policing & Egress Shaping per service
- CIR / PIR (EIR) 2-rate-3-color
- MPLS: TC/EXP-Inferred-PSC (Per Hop Behavior Scheduling Class) LSP

Timing

- SSM quality level compatible
- IEEE 1588 v2 (via SyncE only)
 - PTP Clocks: Ordinary/Boundary/Transparent
 - ToD (Time of day)
 - 1-PPS (One Pulse per second) output interface
 - G.8265.1 Profile (Frequency Synchronization)
- SyncE
 - Synchronous Ethernet from all built-in and plug-in GbE, 10GbE ports
 - ITU-T Ethernet Synchronous Message Channel (ESMC)
- Stratum 3 timing
- TDM line clock: E1/T1 and STM/OC ports
- External clock input and output (2 Mbps / 2 MHz)

Hardware Protection

- Dual-Power redundancy per box
- Dual-Box Redundancy
 - E1 port protection across two boxes
 - Ethernet port LAG across two boxes
 - STM-1/4 port MSP across two boxes

L3 Routing

- VRF without multicast protocols
- ARP, Ping, Trace Route, Static Route
- VRRP
- RIP v1/v2
- OSPF v2
- Routing among Physical Ethernet ports, VLAN virtual port (VLAN routing), and PW ports.
- 32 Subinterfaces
- IGMP v2/v3
- PIM-SM
- NTP server/client

Ordering Information

Note: RoHS compliant units are identified by the letter **G** appearing at the end of the ordering code.

Main Unit

Model	Description	Notes
Loop-G7860A-S- te1-tpr-opt-G	1U height ETSI chassis with 4 GbE SFP ports, 6GbE/10GbE SFP+ ports, 1 Console, and 1 one Ethernet management port, two slots for plug-in modules specified below (order separately), and two power slots specified below (order separately).	<ul style="list-style-type: none"> - For the options of te1, tpr, and opt, please refer to the tables below. - For the options of IEEE 1588 v2 Precision Time Protocol (PTP) function, please refer to the table below. - 10GbE ports can also support 1GbE SFP modules. - Order two for dual-box redundancy

■ **te1** option specifies types of the built-in E1/T1 interface. Please select from the options below.

te1 =	Description	Notes
16TE1	16 port E1/T1 with SCSI interfaces	Conversion panels and cables are listed in the tables below.
[blank]	If blank, it means there are NO E1/T1 ports equipped on the Main Unit.	

■ **tpr** option specifies types of the cooling system. Please select from the options below.

tpr =	Description	Notes
FAN	Chassis with 1 internal fan and 1 air filter for operating temperature: -20 °C to 65 °C	
FL*	Chassis with fan-less version for operating temperature: -20 °C to 65 °C	

* Future option

■ **opt** option specifies types of the alarm board. Please select from the options below.

opt =	Description	Notes
ALM	4 ports of alarm input and 3 ports of alarm output	
[blank]	If blank, it means there is no alarm board equipped on the Main Unit.	

SFP Optical Modules

Please place your order using the 5-digit alphanumeric codes listed in the separate SFP Optical Module Brochure.
NOTE: Non-Loop SFP modules are not guaranteed to work with our equipment. It is strongly recommended to buy Loop-logo SFP modules.

Feature Activation License

IEEE 1588 v2 PTP Software Upgrade (optional)

Loop-G7860A-1588UPGR	Software Upgrade to support IEEE 1588v2. Customers who desire to use the IEEE 1588 v2 Precision Time Protocol (PTP) function can purchase this option. This option will provide an activation code and instructions on how to activate the function on the device. G.8265.1 profile (frequency synchronization) is only available on hardware sub-version 2.
----------------------	--

Plug-in Modules

Plug-in Modules for Main Unit with FAN version (Loop-G7860A-S-te1-FAN-G)

Model	Description	Notes
Loop-G7860A-8GE-G	Eight port Gigabit Ethernet (1000/100/10M BaseT) card with RJ45 connectors for operating temperature: -20 °C to 65 °C	
Loop-G7860A-8GE-4POEP-G*	Eight port Gigabit Ethernet (1000/100/10M BaseT) card with RJ45 connectors, featuring 4 ports with POE/POE+.	
Loop-G7860A-8SFP-G	Eight port GbE card with SFP housing for operating temperature: -20 °C to 65 °C	Please order SFP optical modules separately. See separate SFP module brochure
Loop-G7860A-8SFPA-G*	Eight port GbE/FE card with SFP housing for operating temperature: -20 °C to 65 °C	Please order SFP optical modules separately. See separate SFP module brochure
Loop-G7860A-32TE1-G	32 port T1/E1 (120-ohm) card with SCSI interfaces for operating temperature: -20 °C to 65 °C	Please order separately for conversion panels and cables listed in below tables.
Loop-G7860A-B16-G	Four STM-1/OC-3 or one (w/ or w/o protection) STM-4/OC-12 interfaces without SFP (mini-GBIC) optical modules for operating temperature: -20 °C to 65 °C SDH/SONET software configurable.	Please order SFP optical modules separately. See separate SFP module brochure
Loop-G7860A-6DS3-G	6 port DS3 card with DIN 1.0/2.3 connectors for operating temperature: -20 °C to 65 °C	- 6DS3 plug-in module does not support T2 functions. - For 6DS3 Y-protection, it is required to use with the 6DS3 Y-box (Loop-ACC-Y-12RFC-6BNC-6 DS3-G)

* Future option

Plug-in Modules for Main Unit with Fan-Less version (Loop-G7860A-S-te1-FL-G*)









Model	Description	Notes
Loop-G7860A-8GE-FL-G*	Eight port Gigabit Ethernet (1000/100/10M BaseT) card with RJ45 interfaces for operating temperature: -20 °C to 65 °C Supports fan-less model	
Loop-G7860A-8SFP-FL-G*	Eight port GbE card with SFP interfaces for operating temperature: -20 °C to 65 °C Supports fan-less model	Please order SFP optical modules separately. See separate SFP module brochure
Loop-G7860A-32TE1-FL-G*	32 port T1/E1 (120-ohm) card with SCSI interfaces for operating temperature: -20 °C to 65 °C Supports fan-less model	Please order separately for conversion panels and cables listed in Accessories.
Loop-G7860A-B16-FL-G*	Four STM-1/OC3 or STM-4/OC12 interfaces without SFP (mini-GBIC) optical modules for operating temperature: -20 °C to 65 °C SDH/SONET software configurable. Supports fan-less model	Please order SFP optical modules separately. See separate SFP module brochure

* Future option

Power Modules

Model	Description	Notes
Power Module		
Loop-G7860A-SD48-G	Single -48Vdc power plug-in module (Input voltage: -36 to -72 Vdc)	- Order two power modules to provide power redundancy.
Loop-G7860A-SA-G	Single AC power plug-in module (Input voltage: 100 to 240 Vac)	- Power modules for both AC and DC are situated in the front and back of the G7860A panel. - Applicable for both fan and fan-less version. - For AC, please order an appropriate power cord separately from accessory section below. - AC module protrudes from the panel after being mounted.

Accessories

Model	Description	Notes
Power Cord		
Loop-ACC-PC-USA	AC power cord for Taiwan/America	
Loop-ACC-PC-EU	AC power cord for Europe	
Loop-ACC-PC-UK	AC power cord for UK	
Loop-ACC-PC-AUS	AC power cord for Australia	
Loop-ACC-PC-CH	AC power cord for China	
Conversion Panels		
 Loop-ACC-P-1SCSI-16RJ-G	One SCSI to sixteen RJ (1u height) without cable	- Loop-ACC-P-1SCSI-16RJ-G Dimension: 432x44x23mm (WxHxD)
 Loop-ACC-P-1SCSI-16WW-G	One SCSI to sixteen Wire Wrap (1u height) without cable	- Loop-ACC-P-1SCSI-16WW-G Dimension: 432x44x23mm (WxHxD) - Used with: Loop-G7860A-32TE1-G Loop-G7860A-32TE1-FL-G* Loop-G7860A-S-16TE1-FAN-ALM-G Loop-G7860A-S-16TE1-FAN-G Loop-O9400-R-16TE-G Loop-O9400-R-32TE-G Loop-O9400-R-63TE-G Loop-O9500-R-16TE-G Loop-O9500-R-32TE-G Loop-O9500-R-63TE-G
6DS3 Y-box for 6DS3 plug-in module		
 Loop-ACC-Y-12RFC-6BNC-6DS3-G	1U 6DS3 Y-box with twelve RF DIN 1.0/2.3 connectors to six BNC connectors without cable	- 6DS3 Y-box is required only when 6DS3 module Y-protection is needed. - Dimension: 438x44x80mm (WxHxD) - Weight: 1404g - Used with Loop-G7860A-6DS3-G

- A pair of 19"/23" ear mounts is supplied
- Please purchase 24 pcs of coaxial cable (Loop-ACC-CAB-MRFC-120-M RFC-G) separately for connection between 6DS3 plug-in modules and 6DS3 Y-box

16- and 32-Port HS Y-box for 120/ 100 ohm

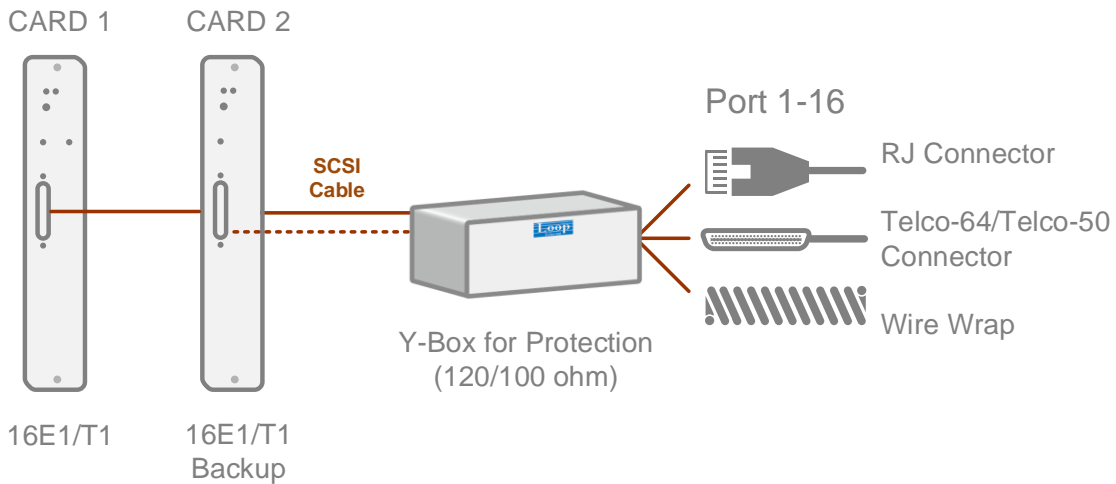

16-port HS Y-Box (120-ohm E1 / 100-ohm T1)
(Loop-ACC-Y-2SCSI-16RJ-G)

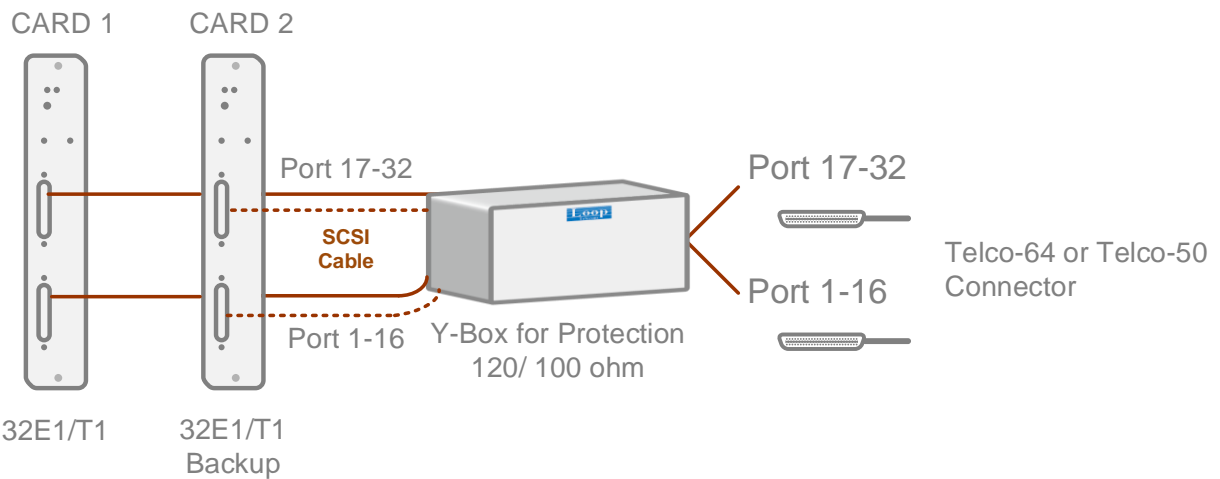





32-port HS Y-Box (120 ohm E1 / 100 ohm T1)
(Loop-ACC-Y-4SCSI- 4T50P8-32TE-G)
(Loop-ACC-Y-4SCSI- 3T50P12-32TE-G)
(Loop-ACC-Y-4SCSI- 2T64P16-32TE-G)



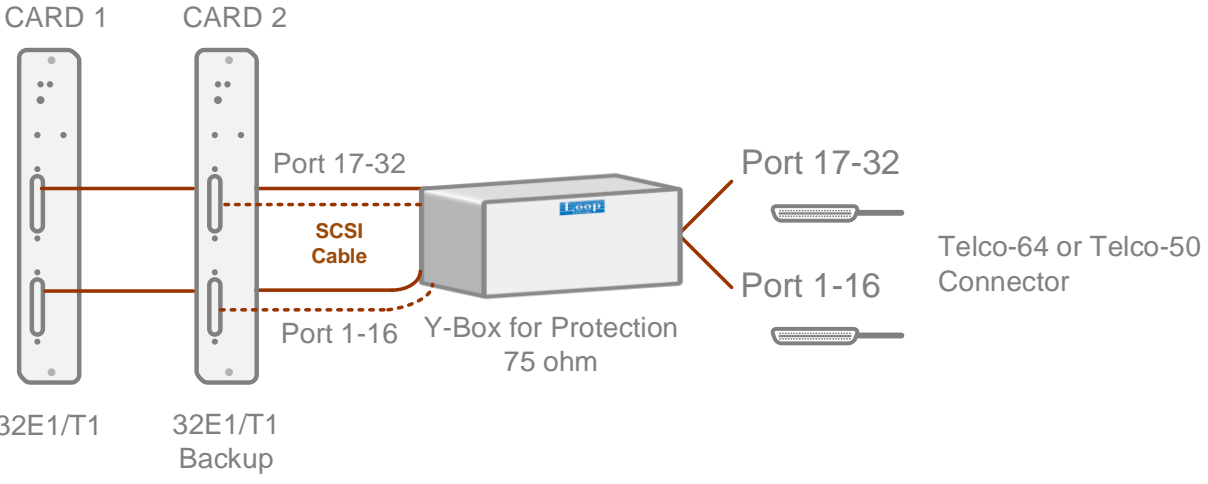

Loop-ACC-Y-2SCSI-16RJ-G

1u 16-port Y-box for two SCSI (120-ohm E1 or 100-ohm T1) to 16 RJ (E1/T1) connectors without cable

- Used with Loop-G7860A-S-16TE1-opt-G
- Dimension: 432x44x100mm (WxHxD)

 <p>Loop-ACC-Y-4SCSI- 4T50P8-32TE-G</p>	<p>1u 32-port Y-box (120-ohm E1 or 100-ohm T1) for four SCSI to four TELCO-50 (120-ohm E1 or 100-ohm T1) connectors (8 ports per TELCO-50 connector) without cable</p>	<ul style="list-style-type: none"> - Used with: Loop-G7860A-32TE1-G Loop-O9400-R-32TE-G Loop-O9400-R-63TE-G Loop-O9500-R-32TE-G Loop-O9500-R-63TE-G
 <p>Loop-ACC-Y-4SCSI- 3T50P12-32TE-G</p>	<p>1u 32-port Y-box (120-ohm E1 or 100-ohm T1) for four SCSI to three TELCO-50 (120-ohm E1 or 100-ohm T1) connectors (12 ports to the first TELCO-50 connector, 12 ports to the second TELCO-50 connector and 8 ports to the third TELCO-50 connector) without cable</p>	<ul style="list-style-type: none"> - Dimension: 432x44x100mm (WxHxD)
 <p>Loop-ACC-Y-4SCSI- 2T64P16-32TE-G</p>	<p>1u 32-port Y-box (120-ohm E1 or 100-ohm T1) for four SCSI to two TELCO-64 (120-ohm E1 or 100-ohm T1) connectors (16 ports per TELCO-64 connector) without cable</p>	
<p>32-Port HS Y-box for 75 ohm</p>		
		
<p>32-port HS Y-Box (75-ohm E1)</p>		
<p>Loop-ACC-Y-4SCSI- 2T64P16-32E75-G</p>	<p>1u 32-port Y-box for four SCSI (120-ohm E1) to two TELCO-64 (75-ohm E1) connectors (16 ports per TELCO-64 connector) without cable</p>	<ul style="list-style-type: none"> - Dimension: 432x44x100mm (WxHxD)
<p>Loop-ACC-Y-4SCSI- 3T50P12-32E75-G</p>	<p>1u 32-port Y-box for four SCSI (120-ohm E1) to three TELCO-50 (75-ohm E1) connectors (12 ports to the first TELCO-50 connector, 12 ports to the second TELCO-50 connector and 8 ports to the third TELCO-50 connector) without cable</p>	<ul style="list-style-type: none"> - Used with Loop-G7860A-32TE1-G Loop-O9400-R-32TE-G Loop-O9400-R-63TE-G Loop-O9500-R-32TE-G Loop-O9500-R-63TE-G
 <p>Loop-ACC-Y-4SCSI- 4T50P8-32E75-G</p>	<p>1u 32-port Y-box for four SCSI (120-ohm E1) to four TELCO-50 (75-ohm E1) connectors (8 ports per TELCO-50 connector) without cable</p>	
<p>Conversion Cable (All conversion cables are RoHS compliant)</p>		
 <p>Loop-ACC-CAB-SCSI68M-200-1SCSI68M-G</p>	<p>SCSI68/ Male to one SCSI68/ Male; Length 200 cm</p>	<ul style="list-style-type: none"> - Used to connect G7860A and end device or intermediate panel. - This cable is also compliant with O9400R and O9500R's Y-Box and conversion panels.

Conversion Cable (All conversion cables are RoHS compliant)		
Loop-ACC-CAB-HDB15M-100-2BNCM-3RJ48M-DB9F- G	One HD-sub 15 pin/ Male connector to two BNC/ Male, three RJ48/ Male, and one DB9/ Female connector; Length: 100 cm	- For Clock interfaces, including external clock, PPS, and ToD Used with: Loop-G7860A-S-te1-tpr-opt- G Loop-O9400-R-CBPA- G Loop-O9500-R-CBPD- G Loop-O9500-R-CBPD-OW- G Loop-O9500-R-CBPD-2POEP- G
Loop-ACC-CAB-SFP10G-100-SFP10G-AOC- G	Stacking cable using SFP+ 10Gbps AOC (Active Optical Cable) Length: 100 cm	- Used to inter-connect two G7860A devices for dual-box redundancy. - Order 5 pcs of stacking cables for a set of G7860A box redundancy.
Loop-ACC-CAB-SFP10G-200-SFP10G-AOC- G	Stacking cable using SFP+ 10Gbps AOC (Active Optical Cable) Length: 200 cm	- Used to inter-connect two G7860A devices for dual-box redundancy. - Order 5 pcs of stacking cables for a set of G7860A box redundancy.
Connection Cable (All conversion cables are RoHS compliant)		
 Loop-ACC-CAB-MRFC-120-MRFC- G	Coaxial cable with RF DIN 1.0/2.3 male plugs at both ends Length: 120 cm	- Used to connect the two 6DS3 plug-in modules to the DS3 Y-box - Each 6DS3 Y-box will require 24 such connection cables. - Each 6DS3 card will require 12 such connection cables
 Loop-ACC-CAB-MRFC-300-BNC- G	Coaxial cable with one RF DIN 1.0/2.3 Male to one BNC Male Length: 300 cm	- Used to connect the DS3 ports on 6DS3/ G7860A with end device or intermediate panel. - Each 6DS3 card will require 12 such connection cables
User's Manual		
Loop-G7860A-UM	User's Manual and Command Line Reference Guide (optional, paper printed copy). Electronic version of both on a CD are already included as standard package.	
SFP Optical Modules		
SFP (small form-factor pluggable) optical modules are NOT included. To order please check the SFP optical module brochure or contact your Loop sales representative.		
Blank Panels		
30.002522.A00LF	Blank panel to cover empty power slot	
30.001862.A00LF	Blank panel to cover empty slot 1 or slot 2	
Fan and Filter Modules		
Loop-G7860A-FAN- G	Combined Fan/Console port module. The console port is on the exterior, and the fan is located inside.	Fan and filter modules are included in main unit Loop-G7860A-S-te1-FAN- G model. Use this ordering code if original fan breaks. For the fanless main unit Loop-G7860A-S-te1-FL- G , fan and filter are not required.
Loop-G7860A-FIL- G	Air filter module for the G7860A	
Ear Mounts		
19"/23" ear mounts	A pair of 19"/23" ear mounts is supplied as part of the standard package. For other sizes please contact your Loop sales representative.	

VoIP Phone		
Loop-ACC-OW-2088-USA-G	Multifunctional IP Phone set with LCD. Includes an external AC power adaptor (AC 100~240V input and DC 5V/ 1A output) for USA/Taiwan	
Loop-ACC-OW-2088-EU-G	Multifunctional IP Phone set with LCD. Includes an external AC power adaptor (AC 100~240V input and DC 5V/ 1A output) for Europe with plug adapter	**

Order Example #1:

Main unit:	
Loop-G7860A-S-16TE1-FAN-G	x 1
Plug-in modules:	
Loop-G7860A-8GE-G	x 2
Power modules:	
Loop-G7860A-SD48-G	x 2
Description:	<ul style="list-style-type: none"> • One 1U height ETSI fan version Main Unit with 16 x E1/T1 with SCSI interfaces, 4 x GbE SFP ports; 6 x GbE/10GbE SFP/SFP+ ports, Console, and NMS RJ45 ports, operation temperature range is -20 °C to 65 °C; • Two plug-in modules each with 8 x GbE (10/100/1000BaseT) RJ45 ports, operation temperature range is -20 °C to 65 °C; • Two DC (-48Vdc input) power modules.

Order Example #2 (For Redundancy):

Main unit:	
Loop-G7860A-S-16TE1-FAN-G	x 2
AOC Stacking cables:	
Loop-ACC-CAB-SFP10G-100-SFP10G-G	x 5
Plug-in modules:	
Loop-G7860A-8GE-G	x 2
Power modules:	
Loop-G7860A-SD48-G	x 4
Description:	<ul style="list-style-type: none"> • Two 1U height ETSI fan version Main Unit with 16 x E1/T1 with SCSI interfaces, 4 x GbE SFP ports; 6 x GbE/10GbE SFP/SFP+ ports, Console, and NMS RJ45 ports, operation temperature range is -20 °C to 65 °C; • Five Stacking cables - SFP+ 10Gbps Active Optical Cables (AOC) ; • Two plug-in modules each with 8 x GbE (10/100/1000BaseT) RJ45 ports, operation temperature range is -20 °C to 65 °C; • Four DC (-48Vdc input) power modules.

Stacking cables (shown in orange) as used in G7860A Chassis Redundancy:

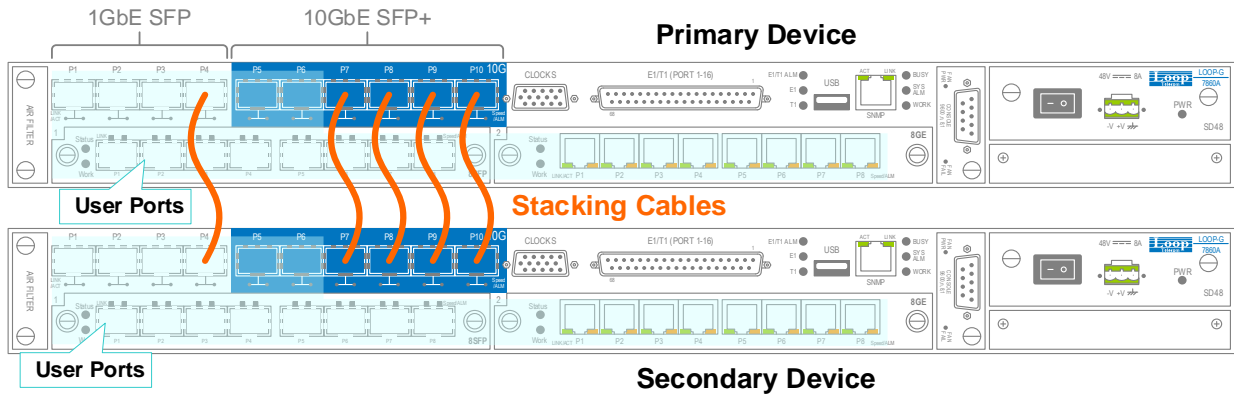

Loop-G7860A Product Specifications

E1 Tributary Interface (plug-in card & built-in)

Number of ports	32TE1 card: 32 ports, two SCSI connectors Built-in: 16 ports, one SCSI connector
Line Rate	2.048 Mbps \pm 50 ppm
Line Code	AMI/ HDB3
Framing	ITU G.704 (CRC: on/off, CAS: on/off, unframed)
Output Signal	ITU G.703
Input Signal	ITU G.703
Jitter	ITU G.823
Connector	SCSI-II 68 pin
E1/T1 mode	software configurable

T1 Tributary Interface (plug-in card & built-in)

Number of ports	2TE1 card: 32 ports, two SCSI connectors Built-in: 16 ports, one SCSI connector
Line Rate	1.544 Mbps \pm 32 ppm
Line Code	AMI / B8ZS (selectable)
Framing	D4 / ESF/ ESF&T1.403/ OFF (clear channel)
Output Signal	DS1 with LBO Setting
Input Signal	DS1
Pulse Template	Per AT&T TR 62411
Connector	SCSI-II 68 pin
E1/T1 mode	software configurable

B155/622 (B16) Interface (plug-in card)

Line Rate	155/622 Mbps
Number of Channels	1 x STM-4/OC-12 or 4 x STM-1/OC-3
Protection	1 x STM-4/OC-12 pair or 2 x STM-1/OC-3 MSP (1+1) pairs Uni-directional /Bi-directional protection switching Revertive/non-revertive protection switching
Operational Modes	SDH (STM-1/4) or SONET (OC3/12) mode software configurable

GbE Interface (plug-in card & built-in)

Ports	Built-in	4 SFP ports
	8GE card	8 RJ45 ports, maximum = 2 cards per chassis
	8SFP card	8 SFP ports, maximum = 2 cards per chassis

GbE/10GbE Interface (Built-in)

Connector	SFP+; use SFP+ module for 10GbE and SFP module for GbE
Number of ports	6

T3 Interface

Number of ports	6DS3 card: 6 ports, 12 DIN(RF) 1.0/2.3 connectors
Connector	DIN (RF) 1.0/2.3
Line Rate	44.736 Mbps
Line Code	B32S
Framing	M-13 / C-bit / Unframed
Output signal	ITU G.703
input signal	ITU G.703
pulse template	Bellcore GR-499-CORE

Note: Only Loop brand optical/electrical SFP modules are certified with full compatibility with G7860A. Please refer to SFP module brochure for detailed SFP specifications.

Management and Administration

Management ports	VT-100 Console (DB9 connector) and Ethernet port (RJ45 connector)
CLI	Fully manageable with Command Line Interface (CLI)
Remote login	Telnet, SSH
SNMP	SNMP v1, v2, v3 via Ethernet port LAN connection

QoS

Eight priority queues
 Scheduling – Strict Priority, Weighted Round Robin (WRR) with hierarchy
 Ingress policing per service
 Egress shaping per service
 Two-rate, three-color – Committed Information Rate (CIR), peak or expected information rate (CIR/PIR)
 E-LSP: EXP-Inferred PSC (Per Hop Behavior Scheduling Class) LSP. (label switching path)
 Congestion management – Weighted Random Early Detection (WRED)

Physical and Environmental

Dimensions (W x H x D)	438 mm x 44 mm x 225.5 mm (17.24" x 1.73" x 8.90")
Net Weight	4.0 Kg (8.82 lbs)
Operating Temperature	-20 to +65 °C
Humidity	5-95% RH (non-condensing)
Mounting	Desk-top stackable, rack mount

Electrical

Power module	2 modules per chassis for redundancy , AC + AC, DC + AC, or DC + DC
DC power module	-48Vdc (-36 to -72V), 8A
AC power module	100 to 240 V, 50/60Hz, 2A

Power consumption

Main Unit	45W
32E1/T1 plug-in card	11W
8GE plug-in card	7W
B16 plug-in card	10W
DS3 plug-in card	27W

Standard Compliance**IEEE**

802.1d	STP
802.1w	RSTP
802.1s	MSTP
802.1q	VLAN
802.1ad	VLAN Tag Stacking (Q-in-Q)
802.1ag	Ethernet OAM (CFM)
802.3ad	Link Aggregation Control Protocol
802.3ah	Ethernet in the First Mile (EFM)
802.3x	Flow Control
1588 v2	Precision Time Protocol (PTP)
802.1AB	Link Layer Discovery Protocol (LLDP)

ITU-T

G.8031	ELPS
G.8032	ERPS
G.8113.2	MPLS-TP OAM
Y.1731	Ethernet OAM

EMC/EMI

FCC Part 15 Class A
EN 55032 Class A
BS EN 55032 Class A
EN 55035
BS EN 55035
EN 50121-4
IEC 61850-3*

RFC (IETF)

6378	MPLS-TP Linear Protection
4842	Circuit Emulation over Packet (CEP)
3985	Pseudowire End-to-end Emulation (PWE3)
5806	CESoPSN

MEF

8
9
14

Safety

EN 62368-1
BS EN 62368-1

* Future option

Front Panel View

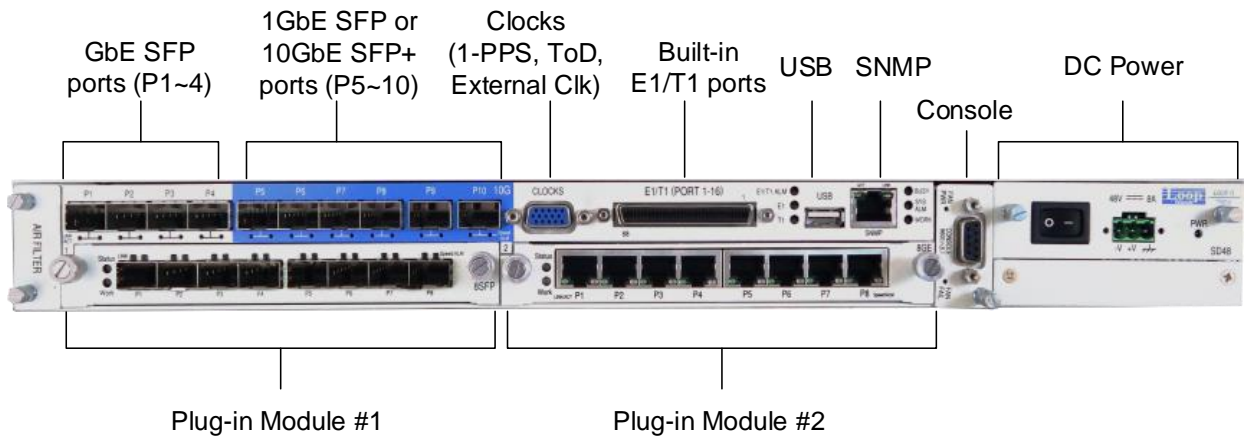

Plug-in Modules

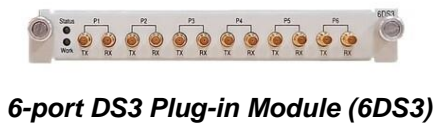
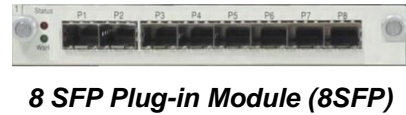
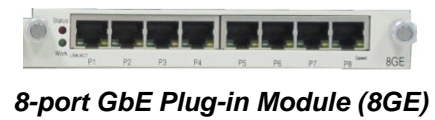

Application Illustration

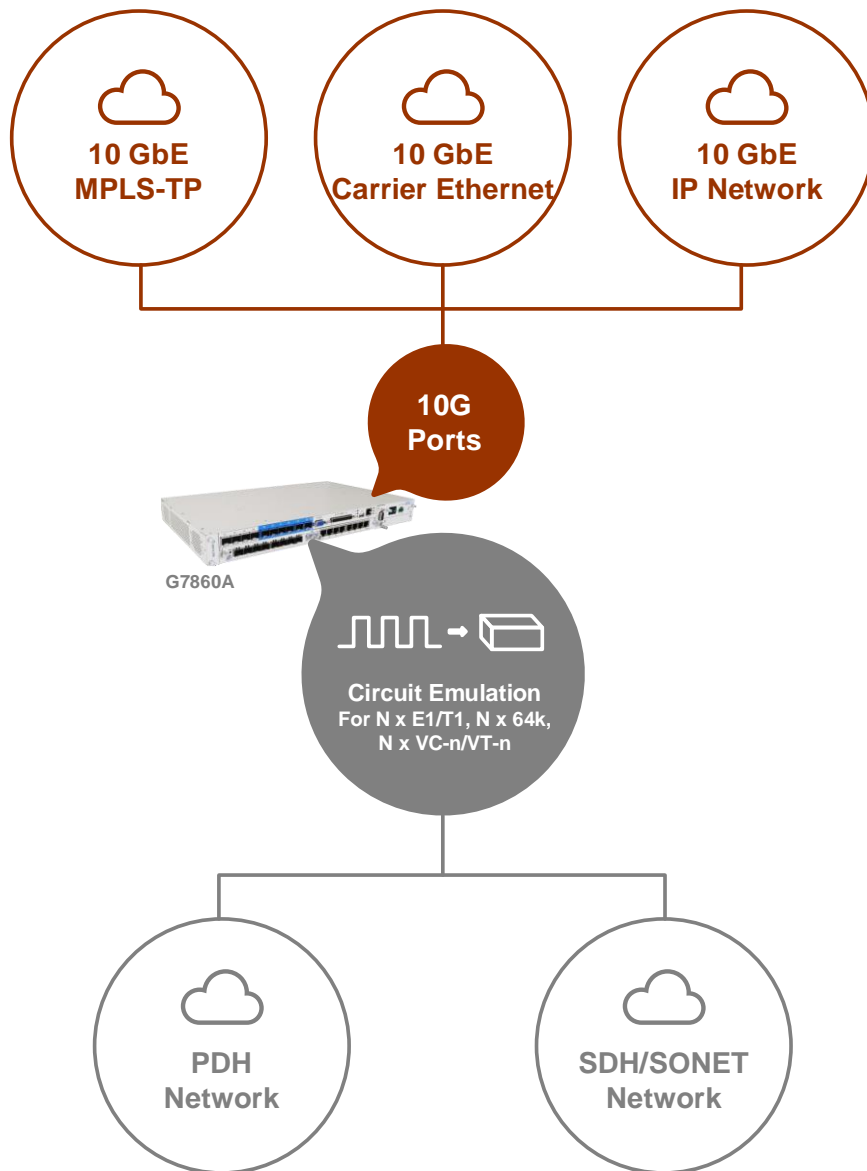

TDM Service Grooming/multiplexing

In addition to native Ethernet traffic, TDM circuits including DS0 timeslots, E1/T1 channels, and SDH/SONET paths can all be emulated as packets via pseudowires, multiplexed by G7860A, and switched to different sites via packet networks.

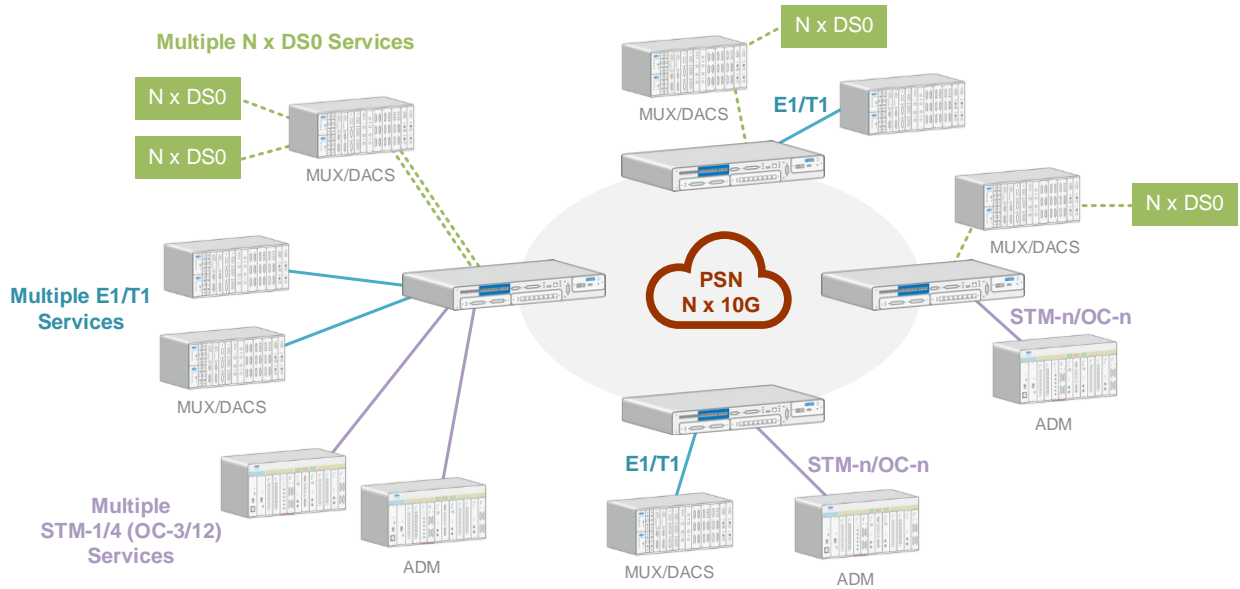

MPLS-TP Protection Schemes

Protection scheme of an MPLS-TP network is standardized as part of the protocol. By deploying static nodes in the network, traffic transported by a tunnel between remote ends is protected by two label switching paths (LSPs) to achieve 1:1 or 1+1 protection.

In 1+1 mode, traffic is copied onto both working and protection LSPs. When receiving traffic, the remote LER only selects traffic from one of the two LSPs to decapsulate.

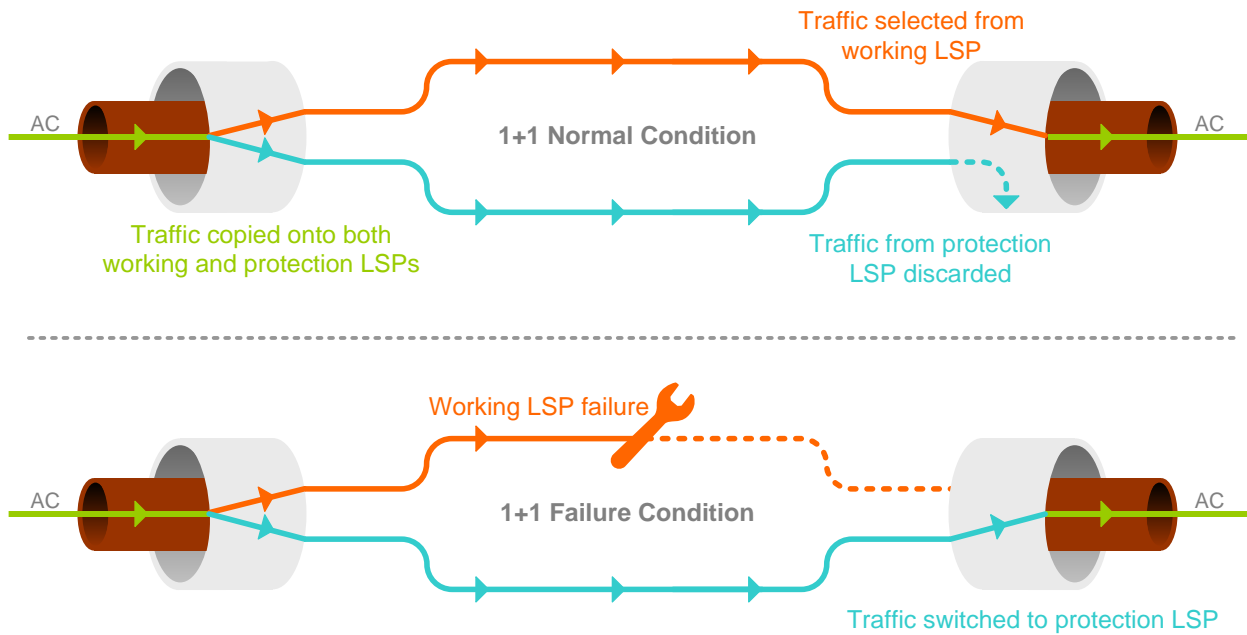

In 1:1 mode, traffic flows only on the working LSP. When a failure occurs on the working LSP, traffic is then switched to the protection LSP within 50 ms.

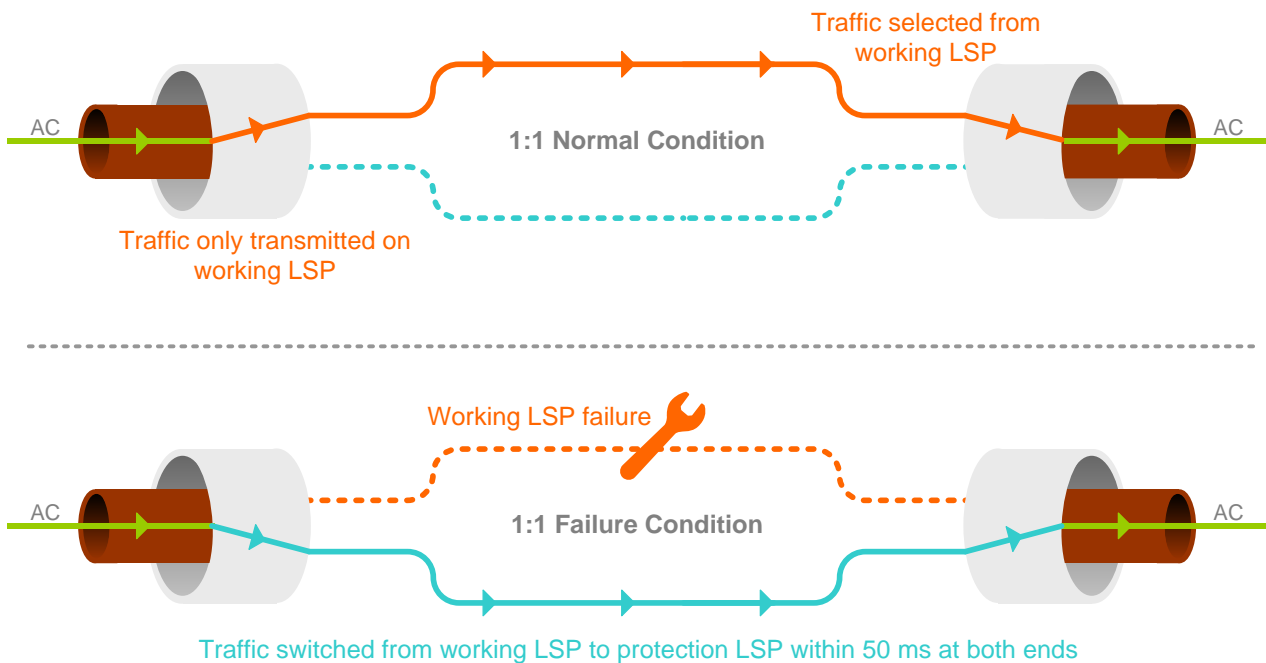

Carrier Ethernet Protection Schemes

In Carrier Ethernet networks, protection schemes of static route provisioning are usually required for service providers to achieve service reliability and monitoring. **Ethernet linear protection switching (ELPS)** standardized in ITU-T G.8031 and **Ethernet ring protection switching (ERPS)** standardized in ITU-T G.8032 are the two most commonly adopted protection schemes.

ELPS is provisioned between two nodes by constructing point-to-point VLAN or Q-in-Q tagging. A pair of lines (i.e. working line and protection line) achieves either **1+1** or **1:1** protection.

In **1:1 protection** mode, traffic only travels on the working line, and will only switch to the protection line when failure of the working line is detected.

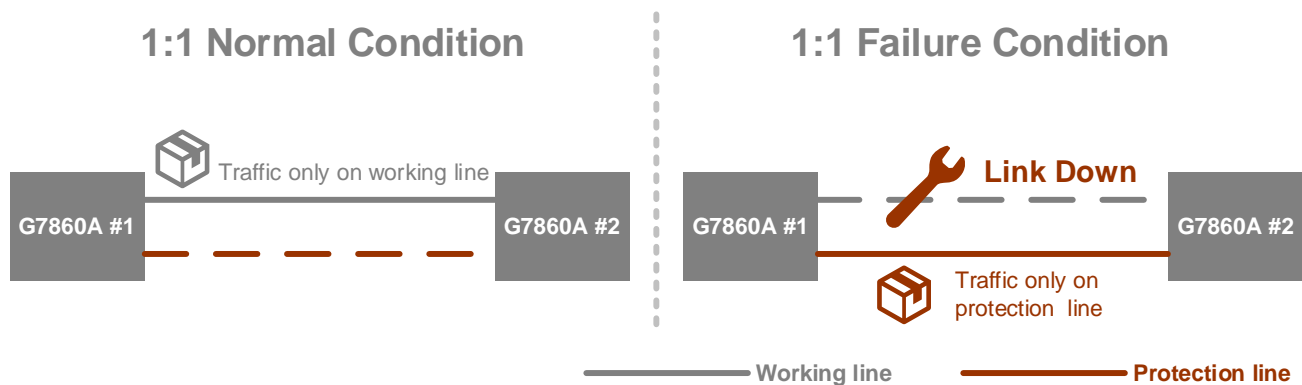

In **1+1 protection** mode, traffic from the head end of a 1+1 link is copied and transmitted on both lines. When line failure occurs in either line, the other line will then become the sole working line.

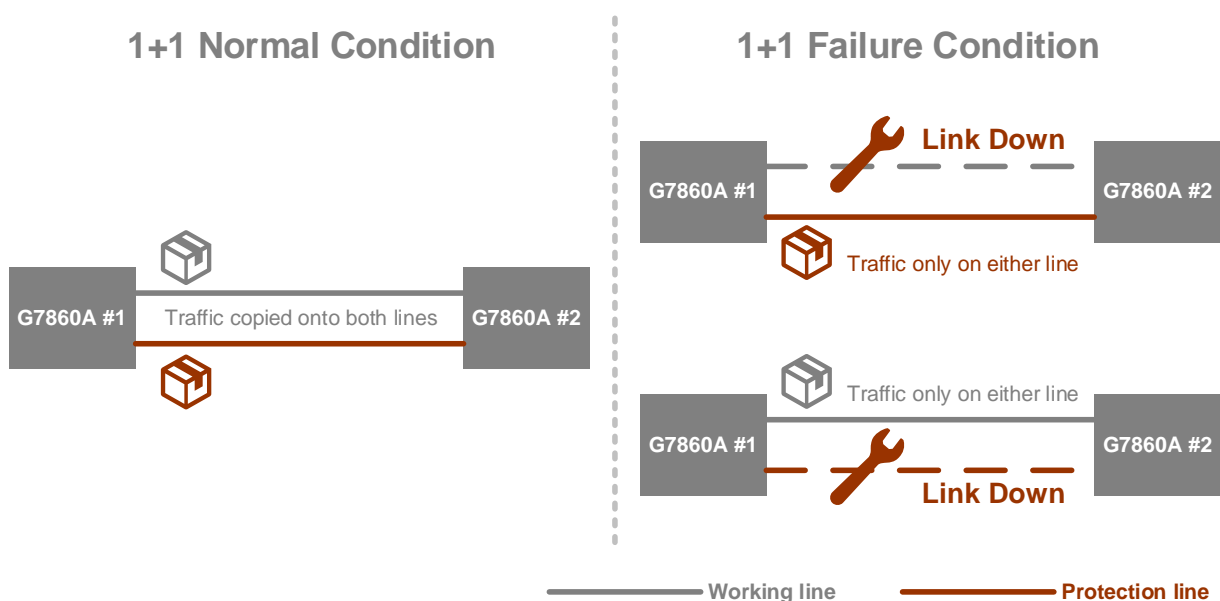

ERPS is a highly reliable and stable protection mechanism in ring networks with loop prevention. In a ring network, each given node is connected to at least two neighbor nodes via separate links. Multiple nodes in tandem then form a ring. Any two nodes in the ring can be connected via at least two paths, serving as a protection scheme. The two ports on both ends of a line on the neighboring devices of the ring are known as ring ports. The minimum amount of nodes in a ring is three. Provisioning is also achieved via VLAN.

To avoid the occurrence of a loop, traffic is allowed to flow on all ring sessions except for the **Ring Protection Link (RPL)**. Under normal conditions, the RPL is blocked from any traffic by the host switches. When a failure in the network is detected, the RPL host unblocks the RPL to allow traffic to pass through. Failure activates protection switching via **Ring Automatic Protection Switching (R-APS)** message relay.

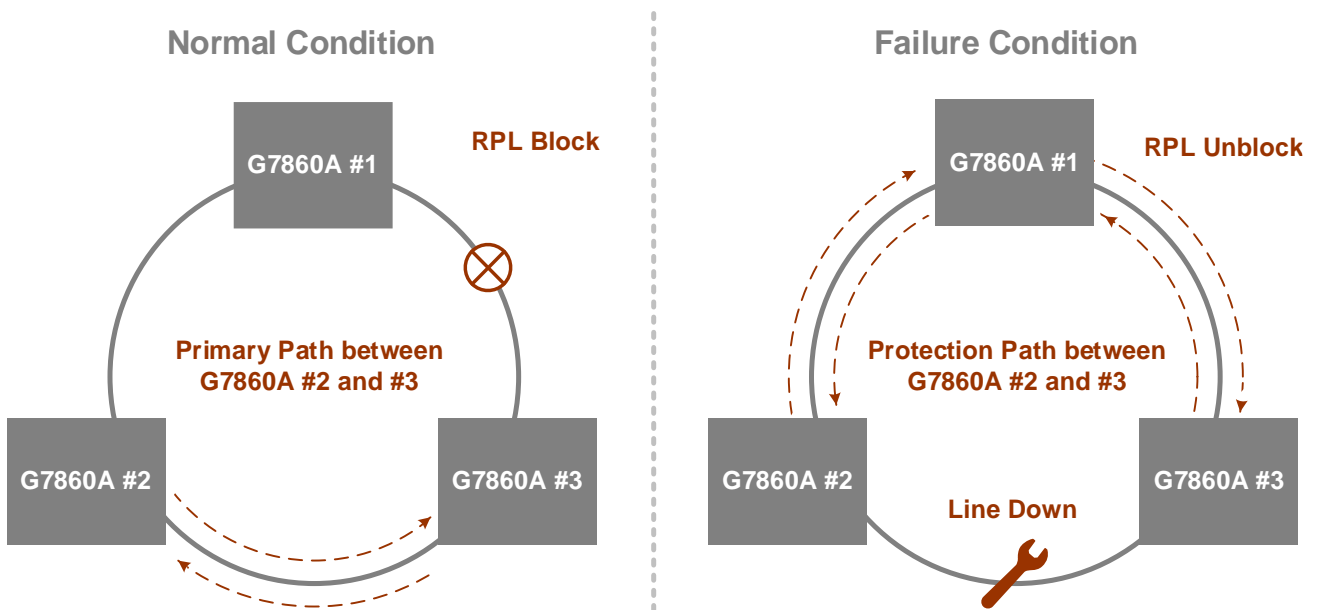

LOOP TELECOMMUNICATION INTERNATIONAL, INC.
 ISO 9001 / ISO 14001 / ISO 27001

Worldwide

6F, No. 8, Hsin Ann Road
 Hsinchu Science Park
 Hsinchu, Taiwan 300092
 +886-3-578-7696

sales@looptelecom.com

Europe

128 Rue La Boetie,
 75008 Paris 08,
 France
 +33-663-71-72-73
 +33-667-67-10-45

eu_sales@looptelecom.com

Americas

8 Carrick Road
 Palm Beach Gardens
 Florida 33418, U.S.A.
 +1-561-627-7947

ncsa_sales@looptelecom.com

Australia & New Zealand

3 Imperial Ave, Mount
 Waverley, Victoria 3149,
 Australia
 +61-413-382-931

aus_sales@looptelecom.com