

SAC-128

TABLE OF CONTENTS

SECTION 1 - DESCRIPTION.....	2
SECTION 2 - SPECIFICATIONS	3
SECTION 3 - INSTALLATION.....	5
SECTION 4 - CONTROLS AND INDICATORS.....	6
SECTION 5 - NETWORK MANAGEMENT PORT	7
SECTION 6 - INTERFACE SIGNALS AND CABLING.....	10
SECTION 7 - TROUBLESHOOTING	14
SECTION 8 - WARRANTY.....	15

Data Comm for Business, Inc.
PO Box 6329
Champaign, IL 61826-6329
(217) 897-6600
www.dcbnet.com

January 13, 2003
Firmware Version: 1.6

8500085

1. DESCRIPTION

The DCB SAC-128 is a synchronous to asynchronous converter that supports asynchronous devices up to 115,200 bps. It allows asynchronous terminal devices to operate over synchronous communication links at speeds up to 128,000 bps. It operates in either point to point or multidrop mode with appropriate DSUs. A companion model, the SR-01, supports asynchronous devices over Frame Relay networks.

The SAC-128 is easy to install and operate. Controls on the unit include the loopback push button switch and an RS-232 management port used to set the asynchronous port speed. The minimum number of controls and comprehensive indicators of the SAC-128 make installation and troubleshooting easy. Diagnostic aids built into the SAC-128 include LED indicators and loopback capabilities.

The synchronous communications network must provide clocking.

Features

- Converts async speeds from 9.6 to 115.2 Kbps to sync at speeds up to 128 Kbps
- RS-232 interface
- Use with any synchronous communications path
- Bi-directional

2. SPECIFICATIONS

2.1 General

DTE Port Rates

Asynchronous rates of 9,600, 19,200, 38,400, 57,600 and 115,200 bps

DCE Port Rates

Synchronous rates up to 128 Kbps

Application

Point-to-point or multidrop

Indicators

Power, Activity, Line Error, Modem Ready, Port 1 Setup, Loopback

Controls

Front panel push button for loopback
Setup via the asynchronous RS-232 port, activated by a front panel push-button, or via rear panel management port

Ports

DTE Port

RS-232, V.24, RJ-45 connector per EIA/TIA 561

DCE Port

RS-232, V.24, RJ-45 connector per EIA/TIA 561

Management port

RS-232, V.24, RJ-45 connector per EIA/TIA 561

2.2 Environmental

Operation: -40 to +70° C, 10 to 95% relative humidity

Storage: -40 to +85° C, 10 to 95% relative humidity

2.3 Physical / Electrical

Power requirements: 120 VAC, wall mount power supply 60 Hz, 18 Watts

10 1/4" x 9 3/4" x 2 1/4"

One pound

2.4 Management Port Commands

- Help
- Show Configuration
- Configure Ports
- Configure Options
- Set Identifier
- Activity Counter
- Zero Counter
- Type
- Repeat Last Command
- Disconnect NMP
- Reset DA

3. INSTALLATION

3.1 Unpacking

The following is included with each unit:

- Unit and external power supply
- Cable for connection to synchronous DCE device (DSU or Modem)
- Cable for connecting a terminal or PC to the Network Management Port for configuration
- Manual
- Information regarding warranty, maintenance contracts and repair

3.2 Location

Place the unit in a clear area where you can reach the front panel for setup and the rear panel to connect the cables. The unit has an external power supply that requires a 120 VAC outlet. The power cord length is about 6 feet.

3.3 Setup

If the default DTE port rate of 57.6 Kbps isn't wanted, use the CP command to set the port rate to 9.6, 19.2, 38.4, 57.6, or 115.2 Kbps.

3.4 Connections

Using the cable provided, connect the Network Composite port to the synchronous DCE device. Connect the DTE device to the DTE port. See Section 6 for port interface and cabling information.

4 CONTROLS AND INDICATORS

4.1 Front Panel Controls

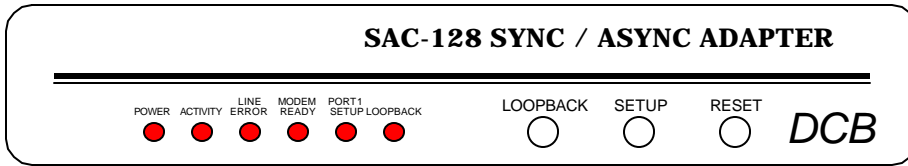

4.1.1 Loopback Switch

Loops the DTE port.

4.1.2 Setup Switch

Enables the unit to be configured using the PC connected to port 1. The Port 1 Setup indicator will light. This makes port 1 operate as a temporary set-up management port. In this state, port 1 should be accessed using a terminal emulator program such as Hyperterm. Press the switch again to return to normal operation.

4.1.3 Reset Switch

Performs a hardware reset. Configuration settings are retained through the reset.

4.2 Indicators

<u>Indicator</u>	<u>Condition</u>	<u>Meaning</u>
Power	ON	Unit has power.
Activity	ON	Device connected to DTE port. (RTS Hi)
Line Error		Not Used
Modem Ready	ON	Network DCD is high.
Port 1 Setup	ON	Network Management Port functions have been mapped to Port 1 for unit configuration. To return to normal operation, press the front panel Port 1 Setup switch.
	OFF	Normal operation. Configuration must be done from the Network Management Port.
Loopback		DTE port in loopback.

5. NETWORK MANAGEMENT PORT

5.1 Introduction

The Network Management port (NMP) provides access to vital statistics and troubleshooting tools. By connecting a terminal or modem to the NMP a vast array of information is at your finger tips. This information can also be accessed via a terminal device (or PC using terminal emulation software) on port 1 when the port 1 setup switch is depressed.

5.2 Connections and Setup

Connection to the NMP is made either through a port on the rear of the unit or by using Port 1 Setup.

5.2.1 Port 1 Setup

The easiest way to access the NMP functions is by using a terminal or PC connected to port 1 of the unit. A switch located on the front panel performs this function. See paragraph 4.1.2 for information. Once the switch is set, no further setup is required.

5.2.2 Dedicated Terminal

The NMP functions are also available through a port on the rear of the unit labeled Network Management Port. To connect a dedicated terminal to this port, use the cable described in paragraph 6.3.2. Set the terminal for 9600 bps, 8 data bits, no parity, one stop bit and no flow control.

5.2.3 Dedicated Modem

For remote access to NMP functions, a dial-up modem may be connected to the Network Management Port. You must fix the DTE interface speed of the modem at 9600 bps, 8 data bits, no parity and one stop bit. Refer to your modem manual for appropriate setup procedures. Use the appropriate cable from paragraph 6.3.2 for connection.

5.3 Using the Network Management port

To activate the NMP, press the ENTER key. When you see **AT YOUR COMMAND >>**, the NMP is active and ready for your commands. Type H <Enter> to display the command set.

5.4 Commands

5.4.1 Help

Displays all available commands.

<u>COMMAND</u>		<u>PARAGRAPH</u>
Show Configuration	SC	5.4.2
Change Port Configuration	CP	5.4.3
Change Options	CO	5.4.4
Set ID	ID	5.4.5
Activity Counters/Zero	AC/Z	5.4.6
Type	TY	5.4.7
Repeat Last Command	*	5.4.8
Disconnect NMP	BYE	5.4.9
Reset DA	RESET	5.4.10

5.4.2 Show (Port) Configuration

Displays the current DTE port rate.

5.4.3 Change Port Configuration

The Change Port Config (CP) command is used to set the DTE port rate. Rates from 9600 to 115,200 bps can be set. The default rate is 57,600 bps.

5.4.4 Change Options

The Change Options (CO) command is used to configure the DTE port to do AT port dialing and set the port for 8 bit plus parity.

5.4.5 Set ID

The Set ID (ID) command allows you to set or change the local unit identifier. IDs can be a maximum of 15 characters in length. Pressing <Enter> with no entry will leave the ID unchanged. The ID is used only when accessing the unit from the NMP. Its use is optional.

5.4.6 Activity Counters / Zero

The Activity Counters (AC) command shows transmit and receive data statistics for the DTE port. The data are presented in terms of blocks of information sent and received by the network and each data port. Error counts are also shown.

The Z command is used to zero the counters so that current activity can be monitored.

5.4.7 Type

The Type (TY) command displays information about the PPP-SR including firmware version, number of ports, unit ID, frame relay parameters, and IP address.

5.4.8 Repeat Last Command

To repeat the last command, simply press the * key. This is handy for repeating screens of constantly changing data.

5.4.9 Disconnect NMP

The BYE command toggles the RTS output from the Network Management port. This is used to disconnect equipment such as dial-up modems or the DCB Access Switch.

5.4.10 Reset DA

To reset the unit type RESET.

6. INTERFACE SIGNALS AND CABLING

6.1 Connector Location and Pin Reference

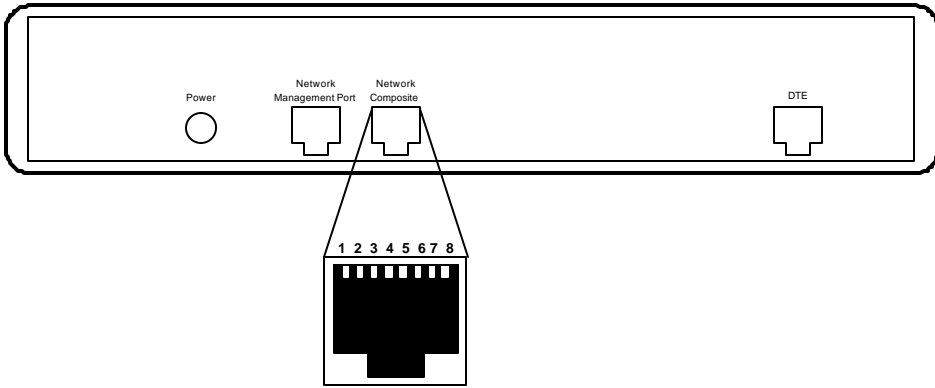

Rear Panel and RJ-45 Jack

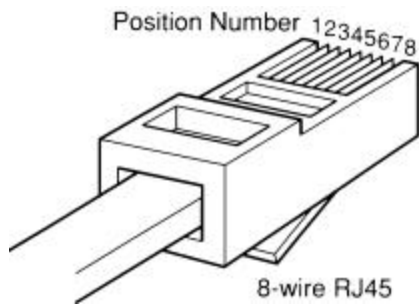

RJ-45 Plug Positions

6.2 Port Interface

6.2.1 DTE Port (RJ-45)

<u>Pin</u>	<u>Signal</u>	<u>In/Out</u>
1	Data Set Ready	OUT
2	Data Carrier Detect	OUT
3	Busy	IN
4	Signal Ground	
5	Receive Data	OUT
6	Transmit Data	IN
7	Clear to Send	OUT
8	Request to Send	IN

6.2.2 Network Management Port (RJ-45)

<u>Pin</u>	<u>Signal</u>	<u>In/Out</u>
1	Not Used	
2	Not Used	
3	Data Carrier Detect	IN
4	Signal Ground	
5	Transmit Data	OUT
6	Receive Data	IN
7	Request to Send	OUT
8	Clear to Send	IN

6.2.3 Composite Port (RJ-45)

<u>Pin</u>	<u>Signal</u>	<u>In/Out</u>
1	Receive Clock	IN
2	Transmit Clock	IN
3	Data Carrier Detect	IN
4	Signal Ground	
5	Transmit Data	OUT
6	Receive Data	IN
7	Request to Send	OUT
8	Clear to Send	IN

6.3 Cables

6.3.1 Composite Port to Modem

A two foot composite to modem cable is included. The wiring diagram is shown below.

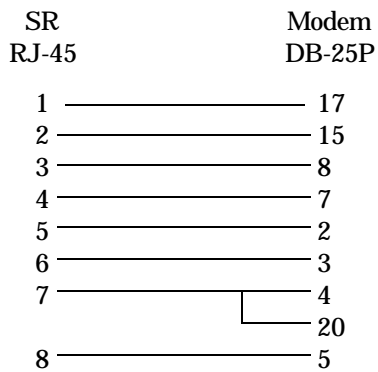

6.3.2 DTE port to a PC

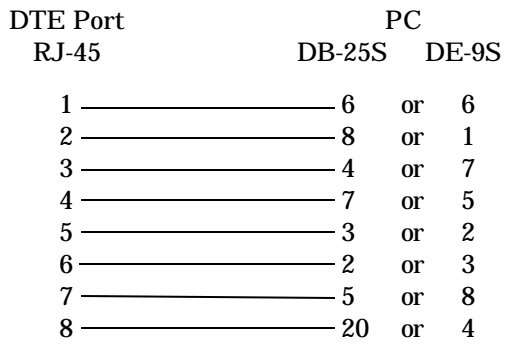

6.3.3 Network Management Port

To a TERMINAL

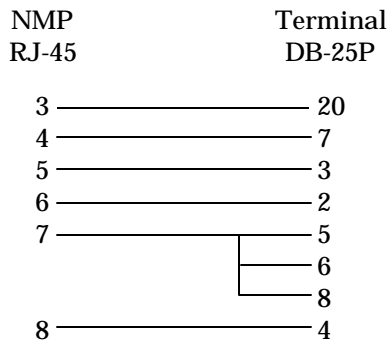

To a PC using terminal emulation

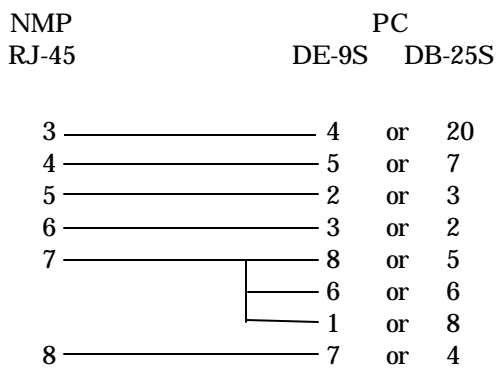

To a dial-up MODEM for remote access

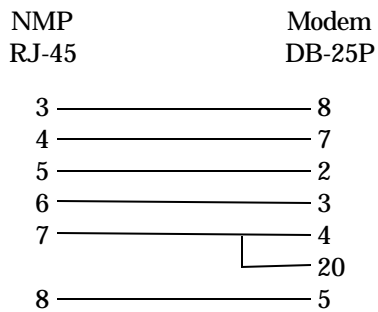

7. TROUBLESHOOTING

7.1 General Approach

When troubleshooting problems, a rational plan can save you many hours of frustration. The following is a brief outline of standard troubleshooting procedures.

1. Gather the facts to determine the exact nature of the problem.
2. Draw a picture of the system showing all equipment at both the host and remote ends and the phone lines or in-house wiring. Use this as a reference to note your observations, test steps and test results. A picture keeps you focused and often saves duplicate effort.
3. Record the front panel indications and all configuration information before changing anything. This is an important part of fact gathering
4. If you change anything, change only one thing at a time.
5. Use the built-in test functions, record your results.

8. WARRANTY

The SAC-128 is warranted to be free of defects in materials and workmanship for two years. Data Comm for Business, Inc. will repair or replace any equipment proven to be defective within the warranty period. All warranty work is F.O.B. Dewey, IL. This warranty is exclusive of abuse, misuse, accidental damage, acts of God or consequential damages, etc. DCB liability shall not exceed the original purchase price.

All equipment returned for repair must be accompanied by a Returned Material Authorization (RMA) number. To receive an RMA number, call (217) 897-6600 between the hours of 8 AM and 5 PM central time. Equipment must be shipped prepaid to DCB and will be returned at DCB's expense.

Ship returned items to:

Data Comm for Business
2949 CR 1000E
Dewey, IL 61840

Data Comm for Business, Inc.
PO Box 6329
Champaign, IL 61826-6329

Tel (217) 897-6600
Fax (217) 897-1331
Email support@dcbnet.com